

HS flex / HS flex heavy

www.hermle.de

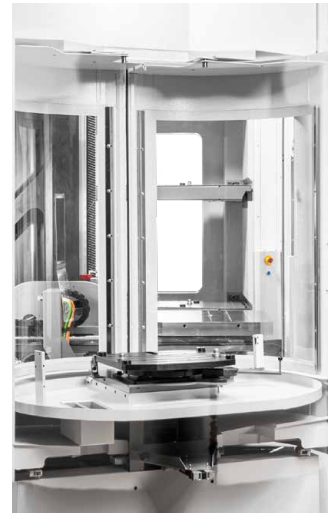

01 Why automation?

Mankind has always been very inventive when it comes to making work easier, avoiding hard and monotonous work and improving productivity. Now the main aims are to increase production times and decrease idle times and downtimes. This minimises the machine-hour rate as well as

personnel costs, giving you a lower capital commitment. Especially in times when highly qualified personnel are in short supply, automation provides an alternative to operation in three shifts guided by personnel.

Average machine utilization (individual production)

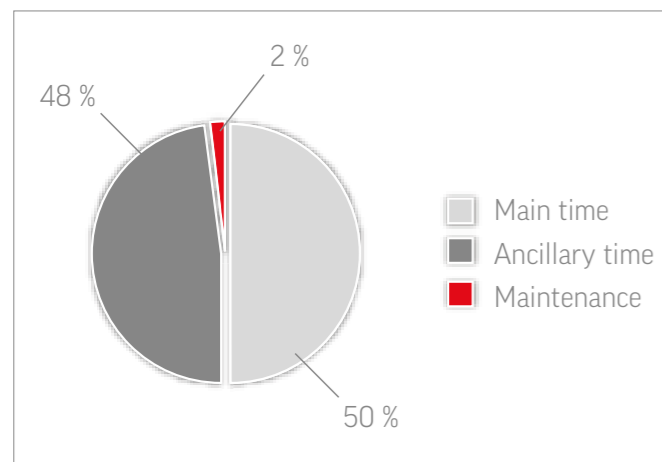

Average machine utilisation (automated production)

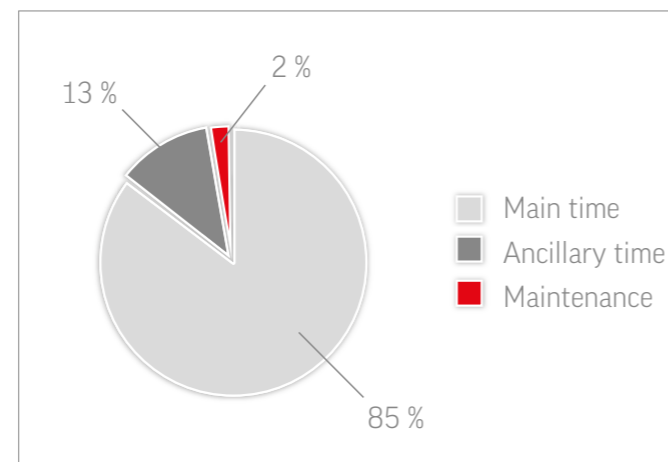

YOUR ADVANTAGES

- Greater production capacity
- Minimized machine-hour rate
- Shorter order throughput time
- Lower capital commitment
- Less manpower dependant
- Fewer shutdowns
- Better time allocation
- Optimised, operator-friendly access to the machining centre
- No floor anchorage required
- Easy and quick installation and commissioning
- HACs management software with intuitive operability

OUR GOAL

Safeguard the competitiveness of Hermle customers in the long term with automation systems that can be used flexibly.

PRECONDITIONS

- Reliable thermostable machine
- Good service, available fast (everything from a single source)
- Flexible automation

02 HACs – Intelligent order management

Our Hermle Automation Control System (HACs), operated via an integrated touch panel, provides an ideal platform for intuitive operation and control of the handling systems.

The intuitive operable software allows intelligent order processing and assists the operator in his daily tasks. The transparent representation of the orders and required operator actions reduce the organisational downtimes and maximise productivity of the plant.



FEATURES

- Forecast of runtime and tool usage
- Intuitive allocation of NC programs and zero points
- Order definition for piece counting, order prioritization and planning
- Dynamic sequence plan change
- Control independent. Available for Siemens and Heidenhain

YOUR ADVANTAGES

- Intuitive operation
- All relevant data at a glance: System overview, work plans, pallets, tasks, tool table and the sequence plan
- Tool analysis: View of tools that are not required next and last time of use tool use (including all NC programs)
- Visualization of the operator tasks for uninterrupted processing of the sequence plan
- Features easy pallet transport with drag and drop
- Reduction of organizational downtimes

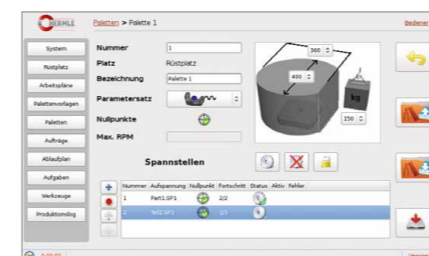
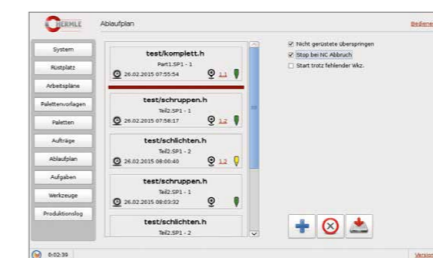

03 System design

The HS flex and HS flex heavy handling systems are automation solutions providing cost-effective entry into machining centre automation. The front-mounted modification ensures a space-saving layout with direct connection to the machining centre. The large intermediate space provides direct access to the working area for manual operator activities. In automatic mode, a double door blocks operator access and in setup mode it blocks access to the handling system. The customisable pallet storage module provides numerous combination options for a large range of parts. A second pallet storage module can also be integrated into the handling system, making for a further significant increase in pallet storage capacity.

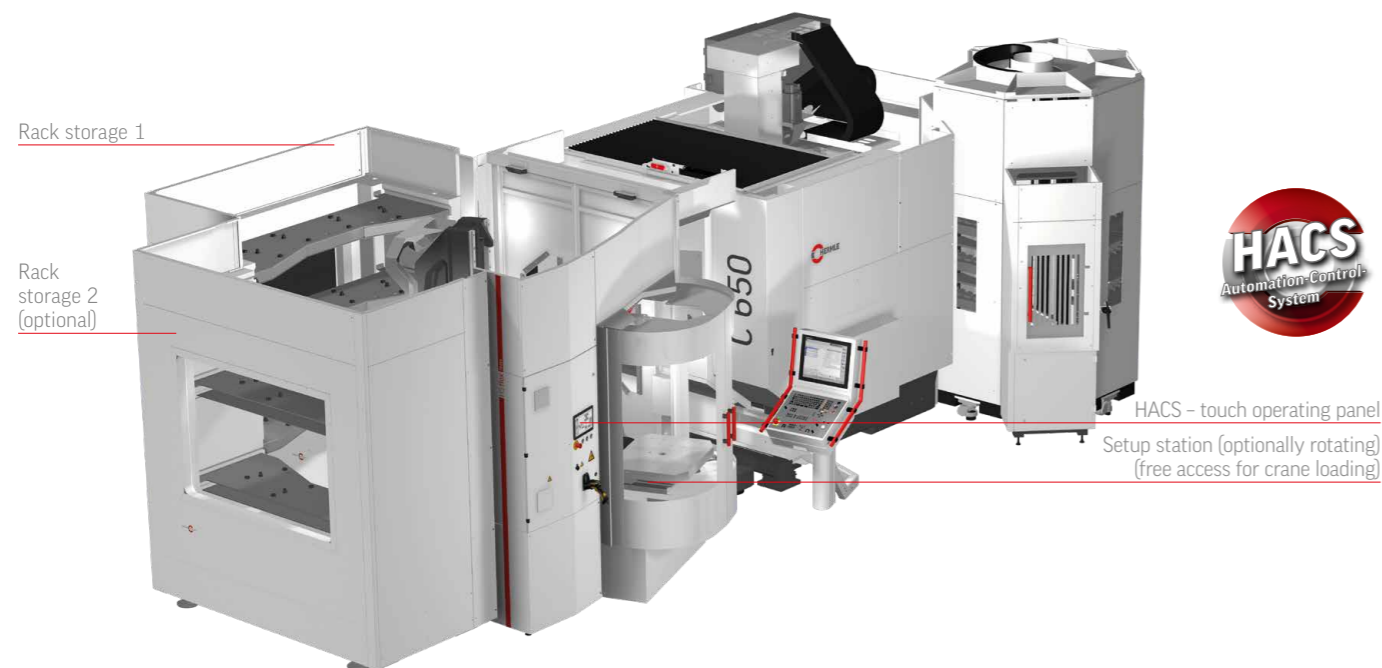
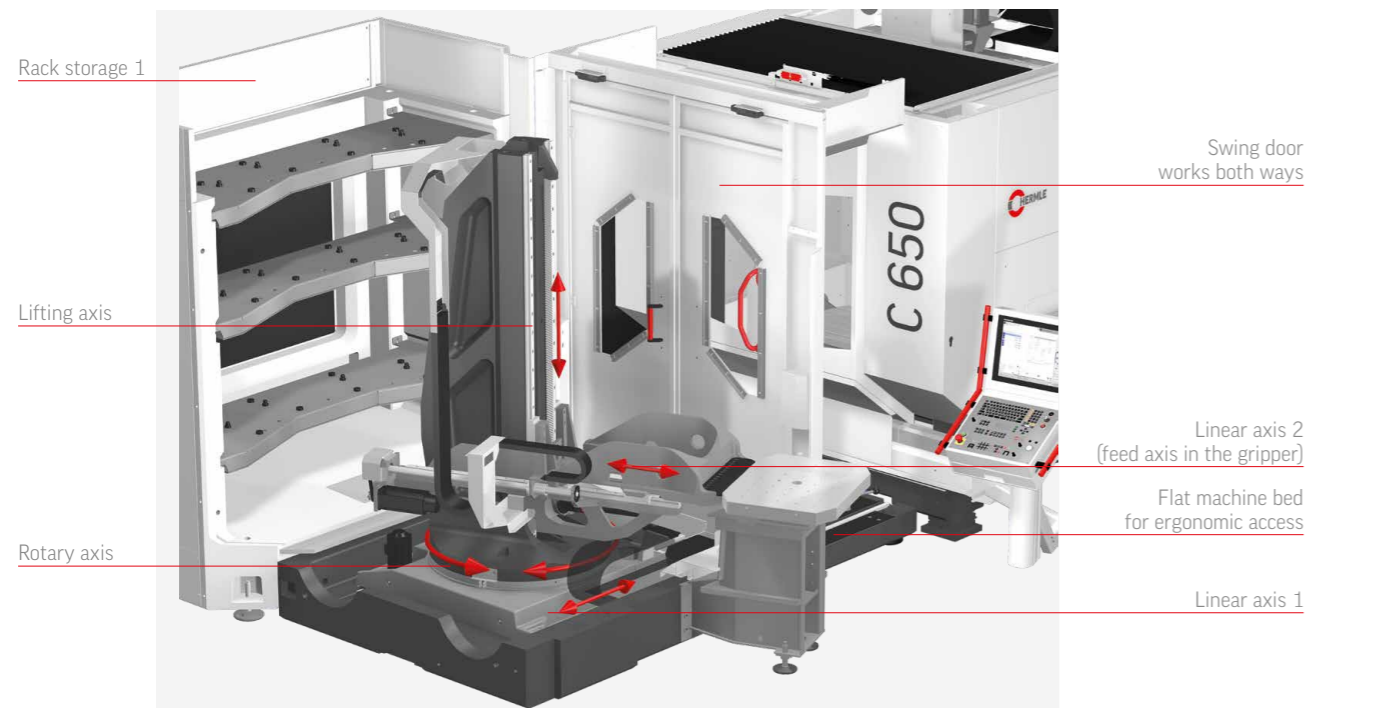





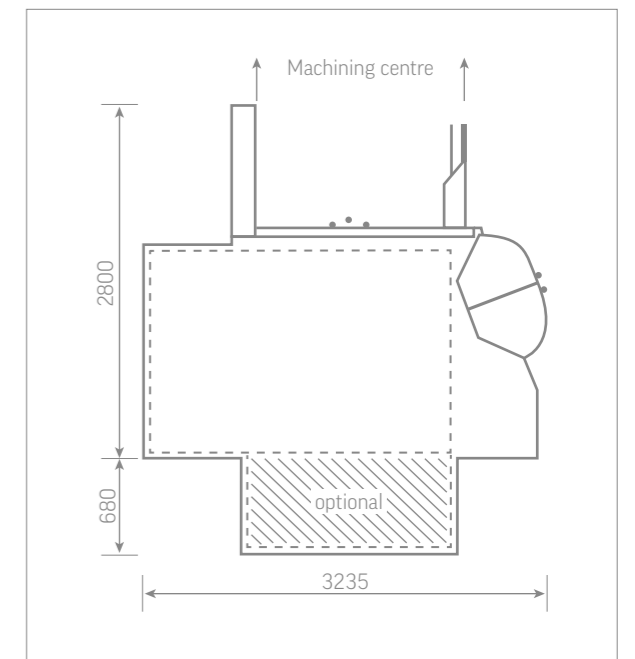















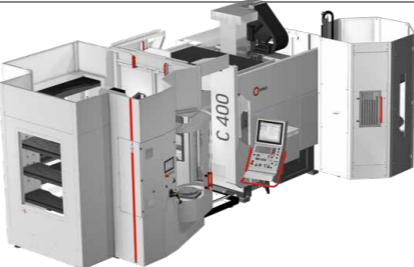





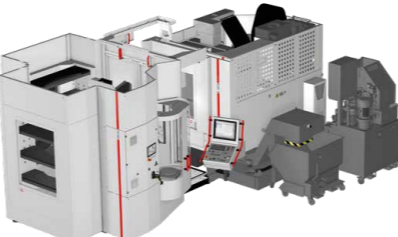



















04 Handling system HS flex

The HS flex handling system can be adapted to six different Hermle machining centres. With a transport weight of up to 450 kg incl. pallet and a storage volume of up to 50 pallet spaces, the HS flex covers a wide application range.



HS flex connectivity

MODEL	PALLET	HS FLEX	WORKPIECE*	STORAGE LOCATIONS
	  240 x 320 320 x 320   400 x 320 400 x 400		 W 500 De 400 Di Ø 500 H 625	 6/3 to 25/5 pockets
	  320 x 320 400 x 400  500 x 400		 W 500 De 400 Di Ø 500 H 625	 6/3 to 12/4 pockets
	  240 x 320 320 x 320		 W 400 De Ø 500 H 625	 9/3 to 25/5 pockets
	  240 x 320 320 x 320   400 x 320 400 x 400		 W 500 De 400 Di Ø 500 H 625	 6/3 to 25/5 pockets
	 240 x 320    320 x 320 400 x 400 400 x 320    320 x 320 400 x 400 500 x 400		 W 500 De 400 Di Ø 500 H 625	 6/3 to 25/5 pockets
	  320 x 320 400 x 400  500 x 400		 W 500 De 400 Di Ø 500 H 625	 6/3 to 12/4 pockets

* Larger workpiece dimensions are also possible if there are free adjacent pockets in rack storage.
 All dimensions are indicated in mm.

05 HS flex heavy handling system

The HS flex heavy handling system can be adapted to four different Hermle machining centres. With a transport weight of up to 1,200 kg incl. pallet and a storage volume of up to 18 pallet pockets, the HS flex heavy covers an extensive application range. Direct crane loading also makes it possible to utilise the maximum table loads of the machining centres to full extent.

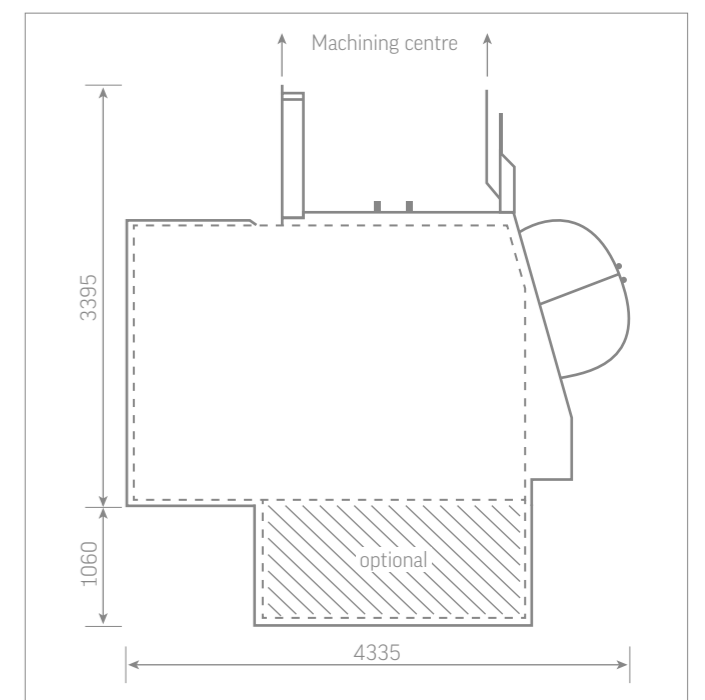
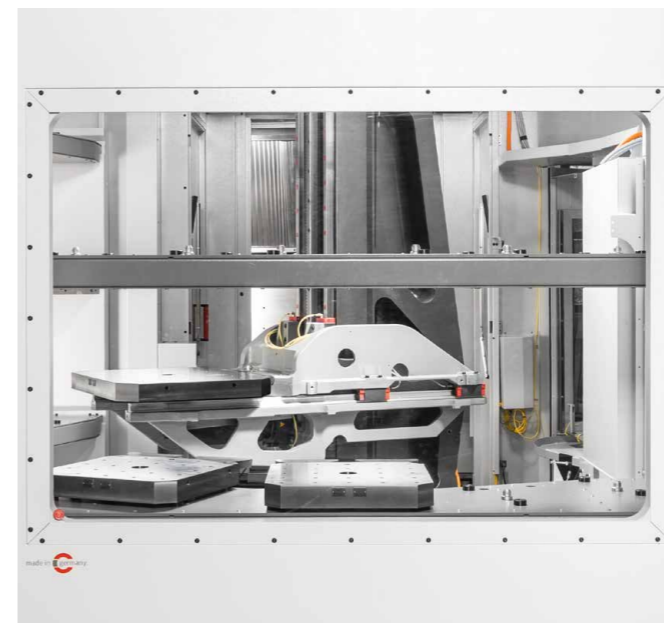

HS flex heavy connectivity

MODEL

PALLET

HS FLEX HEAVY

WORKPIECE *

STORAGE LOCATIONS



C 400



SRT 650 / worm
Single cone
Max. transport weight: 600 kg

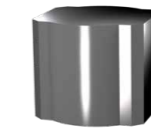

W 800
De 630
Di Ø 800
H 485

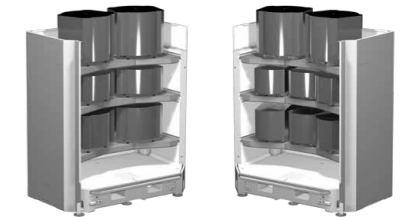

6-fold to 9-fold rack storage



C 650

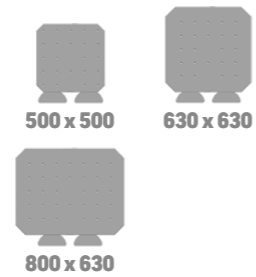

SRT 900 / worm
Double cone
Max. transport weight: 1,200 kg

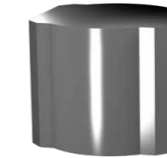

W 800
De 630
Di Ø 800
H 700

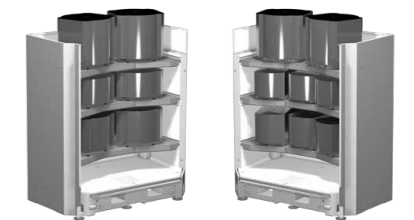

6-fold to 9-fold rack storage



C 32



SRT 650 / torque
Single cone
Max. transport weight: 800 kg

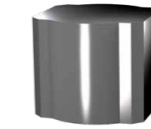
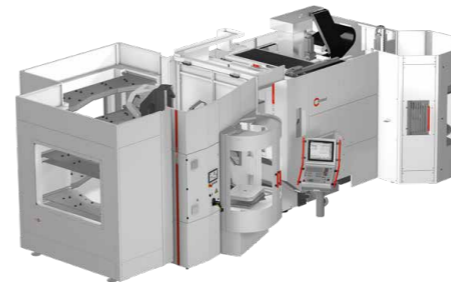

W 726
De 630
Di Ø 800
H 485

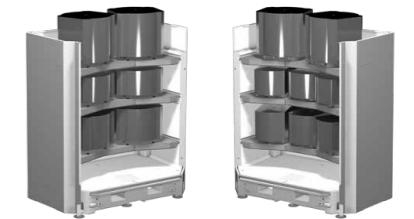

6-fold to 9-fold rack storage



C 42

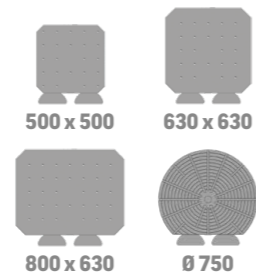

SRT 800 / torque, worm
SRT 750 / torque
Double cone
Max. transport weight: 1,200 kg

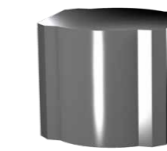

W 800
De 630
Di Ø 800
H 610

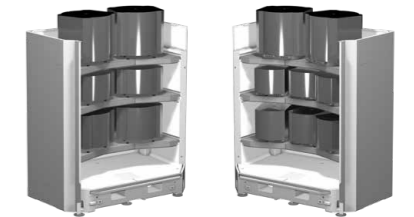

6-fold to 9-fold rack storage

* Larger workpiece dimensions are also possible if there are free adjacent pockets in rack storage.
All dimensions are indicated in mm.

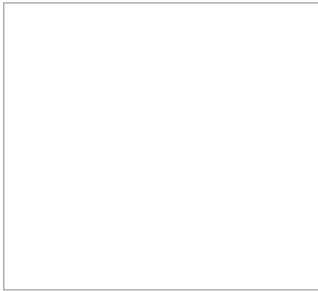

Maschinenfabrik
Berthold Hermle AG
Industriestrasse 8-12
D-78559 Gosheim

Phone +49 (0)7426 95-0
Fax +49 (0)7426 95-1309

info@hermle.de
www.hermle.de

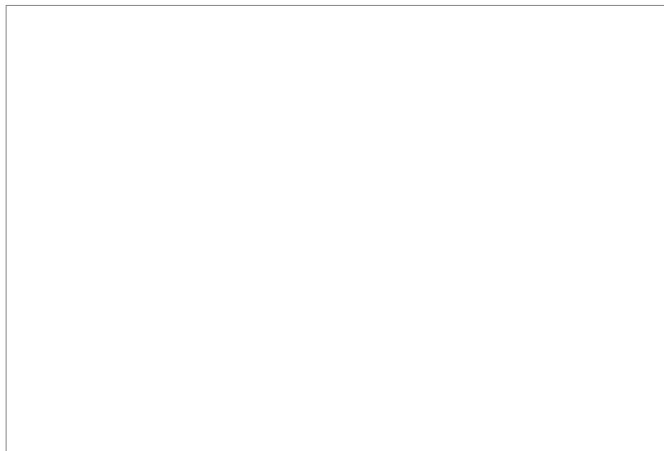

Subject to technical modifications. 03/20/HS flex/HS flex heavy/3000/EN/ST



The machining examples used in this leaflet are published with the explicit and kind permission of our customers. The information in this brochure only contains general descriptions and/or performance features that, in a concrete application, may not always apply in the form described or represented here or may have changed due to further development of the products. The performance features desired shall only be binding if they have been expressly agreed upon in writing at the time of the contract. The machines shown may incorporate options, accessories and control variants.